



Blow guns

prevoS1

27102



CONNECTED TO INNOVATION

Blow guns

prevoS1

Innovation and performance at the core of your business

Compact, compressed air blow guns with embedded plug.

Users will appreciate the easy handling and comfortable grip of the **prevoS1** blow gun in their daily routine. These blow guns are equipped with a precision crafted, nitrided steel plug and compatible with all major connection profile standards. When the blow gun is connected directly into a **prevoS1** quick-safety coupling, they form a seamless, leak-free connection.

Exclusive patented technology.





Manufacturing,
Automotive,
Woodworking...



- Blowing
- Dust removal
- Cleaning
- Drying tools
- Drying work stations...

Technical specifications

- Fluid: **compressed air**
- Recommended pressure: **6 bar**
- Maximum service pressure: **12 bar**
- Service temperature: **-15°C to +70°C**
- Weight: **88 g (for IBG 06MTL)**
- Materials compliant with **RoHS and REACH* directives**



The prevoS1 concept combines performance and innovation in a compact tool with a secure, leak-free connection.

The blow gun, safety coupling and sleeve trio creates a safe, scratch resistant and ergonomic solution.

RoHS Directive: regulation on the restriction of the use of certain hazardous substances in electrical and electronic equipment (lead, mercury, cadmium, hexavalent chromium, polybrominated bi-phenyls –PBBs– and polybrominated di-phenyl ethers –PBDEs)

REACH regulations: on the improvement of the management of risks related to the usage and dangerous properties of chemicals manufactured in or imported into the EU.

SAFETY

- Additional safety with the **prevoS1 quick coupling**
- **OSHA** certified safety nozzle.
Compliant with standard:
“41 CFR § 50-204-8”
and “29 CFR 1910.242.b”



PERFORMANCE

- Powerful blowing force
- Flexible handle for progressive blowing

ENERGY SAVINGS

- Low air consumption
- Embedded, precision crafted plug prevents leaks

LONG SERVICE LIFE

- **Sturdy construction:** provides an extended service life
- **Waterproof body:** water or any external elements cannot infiltrate internal components



EASE TO USE

- User friendly design
- Small footprint: easy to handle and store
- High-tech composite body material: sturdy, lightweight and insulated to regulate temperature.
- Easily hangs to clear workspaces

PLUGS

Each blow gun is equipped with an embedded plug:

The plug is installed directly into the body of the blow gun to create a more compact tool and eliminate leaks when the tool is connected to live air.



prevoS1

Blow guns

The technical data provided is for blow guns uses at 6 bar and applicable for all connection profiles

BLOW GUN prevoS1 with metal nozzle IBG 06MTL

- **Material:** galvanised steel
- **Air consumption:** 20 Nm³/h
- **Noise level:** 89 dBA
- **Blowing force:** 390 g
- **Dynamic pressure at 10 mm:** 2.2 bar
- **Specifications:** long and tapered nozzle, accurate and targeted blowing.



BLOW GUN prevoS1 with OSHA metallic nozzle IBG 06MTLH

- **Material:** galvanised steel
- **Air consumption:** 13 Nm³/h
- **Noise level:** 85 dBA
- **Blowing force:** 248 g
- **Dynamic pressure at 10 mm:** 2.3 bar
- **Specifications:** long and narrow nozzle, powerful blowing



BLOW GUN prevoS1 with protective air screen IBG 06ECR

- **Material:** polyamide composite
- **Air consumption:** 25 Nm³/h
- **Noise level:** 87 dBA
- **Blowing force:** 131 g
- **Dynamic pressure at 10 mm:** 2.1 bar
- **Specifications:** Air screen blow gun, protects against backflow of dust and shavings
- **Non-scratch:** avoids damage to the surrounding material

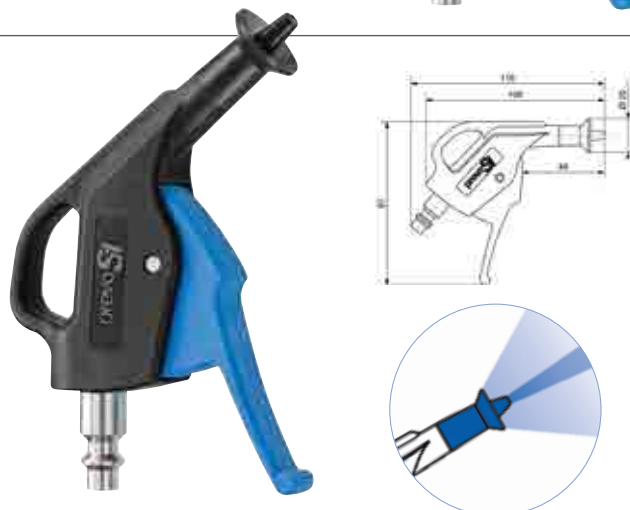

BLOW GUN prevoS1 with OSHA composite nozzle IBG 06OSH

- **Material:** polyamide composite
- **Air consumption:** 13 Nm³/h
- **Noise level:** 87 dBA
- **Blowing force:** 260 g
- **Dynamic pressure at 10 mm:** 1 bar
- **Specifications:** high flow rate, outlet pressure limited to 2 bar
- **Non-scratch:** avoids damage to surrounding surfaces



BLOW GUN prevoS1 with silent nozzle IBG 06SIL

- **Material:** polyamide composite
- **Air consumption:** 9 Nm³/h
- **Noise level:** 74 dBA
- **Blowing force:** 165 g
- **Dynamic pressure at 10 mm:** 0.2 bar
- **Specifications:** silent blow gun, 74 dBA, limits noise in the workshop
- **Non-scratch:** avoids damage to surrounding surfaces

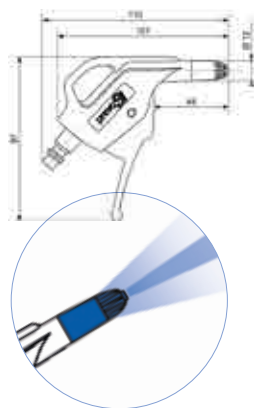

BLOW GUN prevoS1 with straight nozzle IBG 06PRE

- **Material:** polyamide composite
- **Air consumption:** 14 Nm³/h
- **Noise level:** 85 dBA
- **Blowing force:** 286 g
- **Dynamic pressure at 10 mm:** 2.5 bar
- **Specifications:** direct and concentrated blowing
- **Non-scratch:** avoids damage to surrounding surfaces

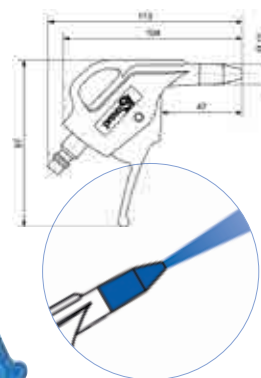

prevoS1 Pocket

BLOW GUN prevoS1 with OSHA composite nozzle IPG 06OSH

- **Material:** polyamide composite
- **Air consumption:** 14 Nm³/h
- **Noise level:** 89 dBA
- **Blowing force:** 168 g
- **Dynamic pressure at 10 mm:** 0.5 bar
- **Specifications:** high flow rate, outlet pressure limited to 2 bar
- **Non-scratch:** avoids damage to surrounding surfaces

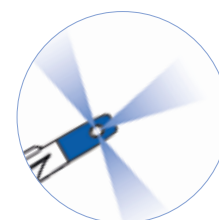
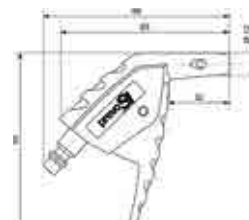

Blow guns **27102**

Efficiency and precision

The 27202 blow gun provides a targeted flow of air that can be controlled with a progressive trigger.

Squeeze the trigger to control the flow of air from a light to powerful stream.



Manufacturing,
Automotive,
Wood working...



- Blowing
- Dust removal
- Cleaning
- Drying tools
- Drying work stations...

Technical specifications

- Utility: **compressed air**
- Recommended pressure: **6 bar**
- Maximum service pressure: **10 bar**
- Service temperature range: **-15°C to +70°C**
- Female thread **BSPP G 1/4**
- Weight: **135 g (for 27102 MTL)**
- Materials compliant with **RoHS and REACH* directives**

DESIGN

- **High-tech composite material:** tough, non-scratch, insulated and non-slip
- Air intake connection with brass **insert** for total safety
- **Hermetically sealed** design to prevent any infiltration of external elements that might block the mechanism
- **Smooth shape** to avoid dust and filings settling on the blow gun body and trigger
- **Easy to hang**

EASY TO USE & MANEUVER

- Minimal effort is required to squeeze the trigger and create a consistent air stream
- The ergonomic design of the pistol grip gun fits perfectly in the palm of the hand
- Accurate air flow: the blowing angle and natural direction of the flow allows precise work
- **Safety nozzles with OSHA versions.** as per the directive: "41CFR § 50-204-8» et «29 CFR 1910.242.b"



RoHS Directive: regulation on the restriction of the use of certain hazardous substances in electrical and electronic equipment (lead, mercury, cadmium, hexavalent chromium, polybrominated bi-phenyls –PBBs– and polybrominated di-phenyl ethers –PBDEs)

REACH regulations: on the improvement of the management of risks related to the usage and dangerous properties of chemicals manufactured in or imported into the EU.

prevoS1

Blow guns

Technical data for blow gun
used at 6 bar

FLOW RATE AT 6 BAR DEPENDENT ON TRIGGER PRESSURE (27102 PRE)

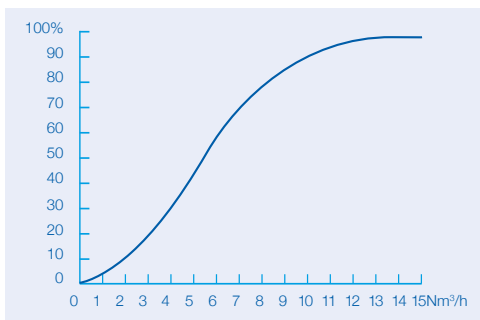

27102 BLOW GUN with metal nozzle 27102 MTL

- **Material:** galvanised steel
- **Air consumption:** 23 Nm³/h
- **Noise level:** 83 dBA
- **Blowing force:** 369 g
- **Dynamic pressure at 10 mm at 1.25 bar**
- **Elbowed length:**
MTL and MTLBP3 = 110 mm
- **Specifications:** metal nozzle,
long and refined

27102 MTLBP3

- Blow gun with limited flow
- When used at 6 bar input, the air flow is equivalent to a standard blow gun with a 3-bar inlet

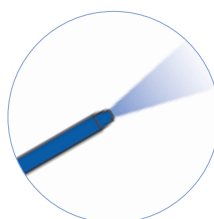
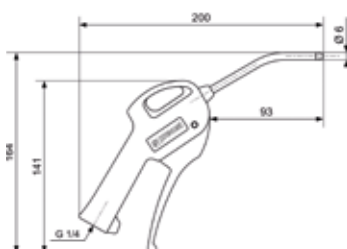

27102 BLOW GUN with composite nozzle OSHA 27102 OSH

- **Material:** polyamide composite
- **Air consumption:** 13 Nm³/h
- **Noise level:** 90 dBA
- **Blowing force:** 270 g
- **Dynamic pressure at 10 mm:** 1.2 bar
- **Elbowed length:** 69 mm
- **Specifications:** high flow rate, outlet pressure limited to 2 bar
- **Non-scratch:** avoids damage to surrounding surfaces

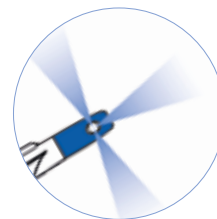

27102 BLOW GUN straight nozzle 27102 PRE

- **Material:** polyamide composite
- **Air consumption:** 15 Nm³/h
- **Noise level:** 84 dBA
- **Blowing force:** 312 g
- **Dynamic pressure at 10 mm:** 2 bar
- **Elbowed length:** 59 mm
- **Specifications:** direct and concentrated blowing
- **Non-scratch:** avoids damage to surrounding surfaces

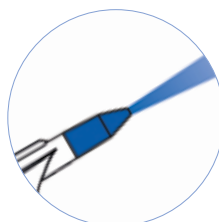

27102 PREBP3

- Blow gun with flow limiter
- With 6 bar input, the airflow is equivalent to that of a standard blow gun with a 3-bar inlet

27102 BLOW GUN with protection air screen 27102 ECR

- **Material:** polyamide composite
- **Air consumption:** 27 Nm³/h
- **Noise level:** 82 dBA
- **Blowing force:** 227 g
- **Dynamic pressure at 10 mm:** 2.5 bar
- **Elbowed length:** 61 mm
- **Specifications:** Air screen blow gun, protects against backflow of dust and shavings
- **Non-scratch:** avoids damage to surrounding surfaces

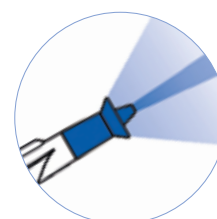

prevoS1

Blow guns

27102 BLOW GUN with silent nozzle 27102 SIL

- **Material:** polyamide composite
- **Air consumption:** 12 Nm³/h
- **Noise level:** 77 dBA
- **Blowing force:** 213 g
- **Dynamic pressure at 10 mm:** 0 bar
- **Elbowed length:** 59 mm
- **Specifications:** silent blow gun, 77 dBA, reduces noise in the workshop
- **Non-scratch:** avoids damage to surrounding surfaces

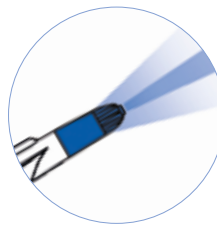

27102 BLOW GUN with OSHA nozzle and VENTURI effect 27102 VEN

- **Material:** steel
- **Air consumption:** 12 Nm³/h
- **Noise level:** 103 dBA
- **Blowing force:** 264 g
- **Dynamic pressure at 10 mm:** 0.21 bar
- **Elbowed length:** 86 mm
- **Specifications:** The Venturi system of the nozzle provides a powerful blast for cleaning large areas, without increasing energy consumption. Outlet pressure restricted to 2 bar

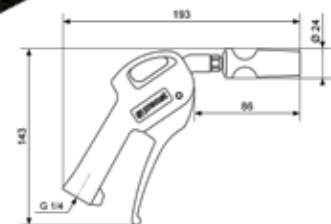

27102 BLOW GUN BODY adaptable

- **Material:** brass
- **Specifications:** deformable long nozzle; Female thread 1/8



27102 BLOW GUN with long metal nozzle 27102 MB13

- **Material:** galvanised steel
- **Air consumption:** 15 Nm³/h
- **Noise level:** 86 dBA
- **Blowing force:** 264 g
- **Dynamic pressure at 10 mm:** 1.7 bar
- **Elbowed length:** 330 mm
- **Specifications:** long nozzle to access hard-to-reach zones

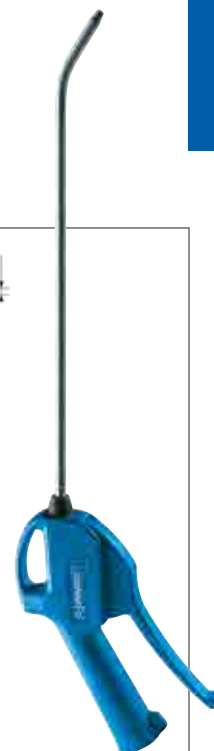
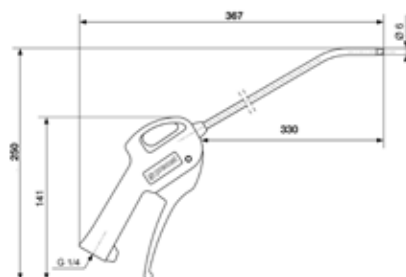

27102 BLOW GUN with metal nozzle 27102 MB20

- **Material:** galvanised steel
- **Air consumption:** 15 Nm³/h
- **Noise level:** 86 dBA
- **Blowing force:** 244 g
- **Dynamic pressure at 10 mm:** 1.5 bar
- **Elbowed length:** 500 mm
- **Specifications:** long nozzle to access hard to reach areas

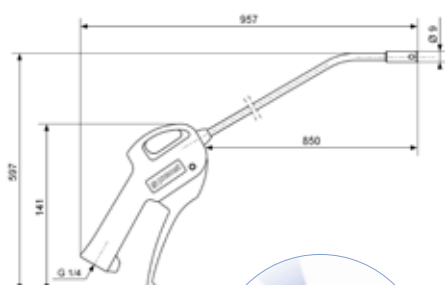
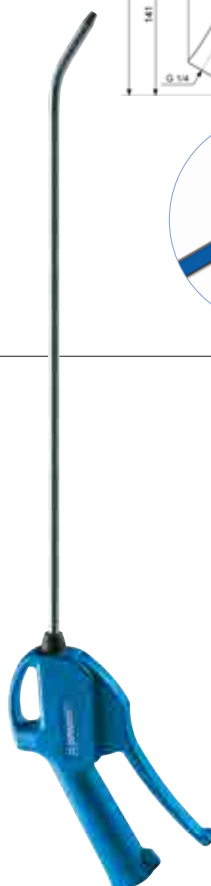
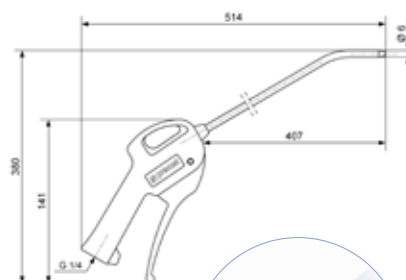

27102 BLOW GUN with metal OSHA nozzle 27102 MB40OSH

- **Material:** galvanised steel
- **Air consumption:** 9 Nm³/h
- **Noise level:** 81 dBA
- **Blowing force:** 186 g
- **Dynamic pressure at 10 mm:** 2.5 bar
- **Elbowed length:** 1000 mm
- **Specifications:** long nozzle to reach hard-to-reach areas, output pressure limited to 2 bar



Mounting bracket

A blow gun always at hand

Reduce clutter on your workstation with the BG FIX wall bracket. Your tool will always be close at hand and easy to access.

This bracket is also available in a magnetic version: BG FIXM.

The two built in magnets allow the unit to be moved to different convenient locations.



WALL MOUNTING BRACKET BG FIX / BG FIXM

- **Wall mount for Blow Gun (extra-safe design):** allows a quick release, without damaging either the holder or the blow gun
- **Compatible with prevoS1 and 27102**
- **Attachment spacing: 70 mm**

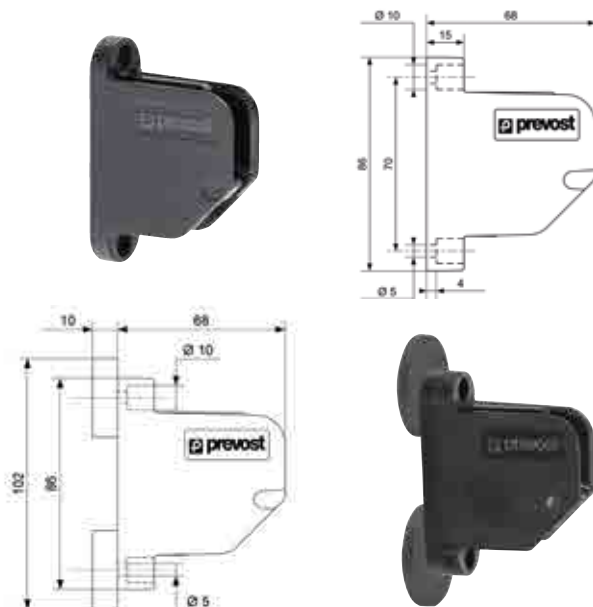



PREVOST UK Ltd
UNIT G, Tower Business Park – Commercial Road –BB3 0FJ DARWEN
LANCASHIRE – UNITED KINGDOM
Phone. (+44) 01254 873 389
sales@prevost-ltd.co.uk - www.prevost.eu

