

# Dynabug® II

10,000 RPM, 3/32" Orbit

Parts Page Reorder No. APD10•04  
Effective March, 2010  
Supersedes APD09•04

## Tool Manual – Safety, Operation and Maintenance

SAVE THIS DOCUMENT, EDUCATE ALL PERSONNEL

**Models:**

<b>10280</b> - Non-Vacuum	<b>Pads: Hook</b> (74 mm x 109 mm)
<b>10281</b> - Non-Vacuum	(68 mm x 175 mm)
<b>10282</b> - Central Vacuum	(74 mm x 109 mm)
<b>10283</b> - Non-Vacuum	(80 mm x 130 mm)
<b>10285</b> - Central Vacuum	(80 mm x 130 mm)
<b>10290</b> - Central Vacuum	(99 mm x 143 mm, delta-style)
<b>10292</b> - Central Vacuum	(68 mm x 196 mm)
<b>10291</b> - Central Vacuum	<b>Pad: Loop</b> (68 mm x 196 mm)
<b>10287</b> - Non-Vacuum	<b>Pad: Vinyl</b> (68 mm x 175 mm, w/clips)

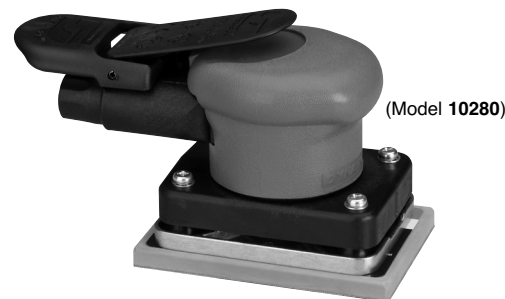
FIND THE MOST CURRENT OFFERING OF SUPPORT DOCUMENTS AND ACCESSORIES @ [WWW.DYNABRADE.COM](http://WWW.DYNABRADE.COM)

## ! WARNING

Read and understand this tool manual before operating your air tool. Follow all safety rules for the protection of operating personnel as well as adjacent areas. Always operate, inspect and maintain this tool in accordance with the American National Standards Institute (ANSI) Safety Code for Portable Air Tools – B186.1. For additional safety information, refer to Safety Requirements for the Use, Care and Protection of Abrasive Wheels – ANSI B7.1, Code of Federal Regulation – CFR 29 Part 1910, European Committee for Standards (EN) Hand Held Non-Electric Power Tools – Safety Requirements and applicable State and Local Regulations.

## SAFETY LEGEND

**! WARNING**

Read and understand tool manual before work starts to reduce risk of injury to operator, visitors, and tool.

**! WARNING**

Practice safety requirements. Work alert, have proper attire, and do not operate tools under the influence of alcohol or drugs.

**! WARNING**

Eye protection must be worn at all times, eye protection to conform to ANSI Z87.1.

**! WARNING**

Ear protection to be worn when exposure to sound, exceeds the limits of applicable Federal, State or local statutes, ordinances and/or regulations.

**! WARNING**

Respiratory protection to be used when exposed to contaminants that exceed the applicable threshold limit values required by law.

**! WARNING**

Air line hazard, pressurized supply lines and flexible hoses can cause serious injury. Do not use damaged, frayed or deteriorated air hoses and fittings.

**! WARNING**

Some dust created by grinding, drilling, and other construction activities contain chemicals known to cause cancer, birth defects or other reproductive harm. Some examples of these chemicals are:

- Lead from lead-based paints
- Crystalline silica from bricks and cement and other masonry products
- Arsenic and chromium from chemically treated lumber

Your risk from these exposures varies, depending on how often you do this type of work. To reduce your exposure to these chemicals: work in a well ventilated area, and work with approved safety equipment, such as those dust masks that are specially designed to filter out microscopic particles.

### SAFETY INSTRUCTIONS

Carefully Read all instructions before operating or servicing any Dynabrade® Abrasive Power Tool.

Products offered by Dynabrade are not to be modified, converted or otherwise altered from the original design without expressed written consent from Dynabrade, Inc.

**Tool Intent:** Dynabug® II Sander is used for sanding and finishing a variety of materials including wood, metal, plastic, fiberglass, solid surfaces, composites, rubber, glass and stone.

Do not use tool for anything other than its intended applications.

This power tool is not intended for use in potentially explosive atmospheres and is not insulated against contact with electrical power.

**Training:** Proper care, maintenance, and storage of your tool will maximize its performance.

- Employer's Responsibility – Provide Dynabug® II operators with safety instructions and training for safe use of tools and accessories.

**Accessory Selection:**

- Abrasive/accessory RPM (speed) rating MUST be approved for AT LEAST the tool RPM rating.

(continued on next page)

## SAFETY INSTRUCTIONS (Cont.)

- Use only recommended accessories. See back page of manual and Dynabrade Literature.
- Before mounting an accessory, visually inspect for defects. Do not use defective accessories.
- Follow tool specifications before choosing size and type of accessory.
- Only use recommended fittings and air line sizes. Air supply hoses and air hose assemblies must have a minimum working pressure rating of 150 PSIG (10 bars, g) or 150 percent of the maximum pressure produced in the system, whichever is higher. (See Tool Machine Specifications Table.)

## OPERATING INSTRUCTIONS

**Warning:** Always wear eye protection. Operator of tool is responsible for following: accepted eye, face, respiratory, hearing and body protection.

**Caution:** Hand, wrist and arm injury may result from repetitive work, motion and overexposure to vibration.

**Caution:** Be sure that any loose clothing, hair and all jewelry is properly restrained.

- Install air fitting into inlet bushing of tool. Important: Secure inlet bushing of tool with a wrench before attempting to install the air fitting to avoid damaging valve body housing.
- BEFORE MOUNTING AN ACCESSORY, after all tool repairs and whenever a tool is issued for use, check tool OPM (speed) with tachometer with air pressure set at 90 PSIG while the tool is running. This tool is an orbital tool, checking the OPM requires either a strobe or magnetic tachometer. If tool is operating at a higher speed than the RPM marked on the tool housing, or operating improperly, the tool must be serviced and corrected before use.

**Caution:** Tool RPM / OPM must never exceed abrasive/accessory RPM / OPM rating. Check accessory manufacturer for details on maximum operating speed or special mounting instructions.

- With power source connected at the air tool relieve hose of air pressure and disconnect tool from air supply when changing recommended accessories.
- Connect air tool to power source. Be careful NOT to depress throttle lever in the process.

**Do not expose air tool to inlet pressure above 90 PSIG or (6.2 Bars).**

**Caution:** After installing the accessory, before testing or use and/or after reassembling tool, the tool must be started at a reduced speed to check for good balance. Gradually increase tool speed. DO NOT USE if tool vibration is excessive. Correct cause, and retest to insure safe operation.

- Use only appropriately sized abrasive sanding sheets properly secured and aligned to the backing pad provided with the air sander.
- When applying the sander to a work surface **start-on** and **stop-off** when completed.
- Make sure that work area is uncluttered, and visitors are at a safe range from the tools and debris.
- Potentially explosive atmospheres can be caused by dust and fumes resulting from sanding or grinding. Always use dust extraction or suppression systems which are suitable for the material being processed.
- Proceed with caution in unfamiliar surroundings. Hidden hazards may exist, such as electricity or other utility lines.
- Use only Dynabrade weight-mated pads to maintain low vibration levels.
- Use a vise or clamping device to hold work piece firmly in place.
- Work may generate hazardous dust.
- Do not apply excessive force on tool or apply "rough" treatment to it.
- Always work with a firm footing, posture and proper lighting.
- Ensure that sparks and debris resulting from work do not create a hazard.
- This tool is rear exhaust. Exhaust may contain lubricants, vane material, bearing grease, and other materials flushed through the tool.

**Report to your supervisor any condition of the tool, accessories, or operation you consider unsafe.**

## Air System

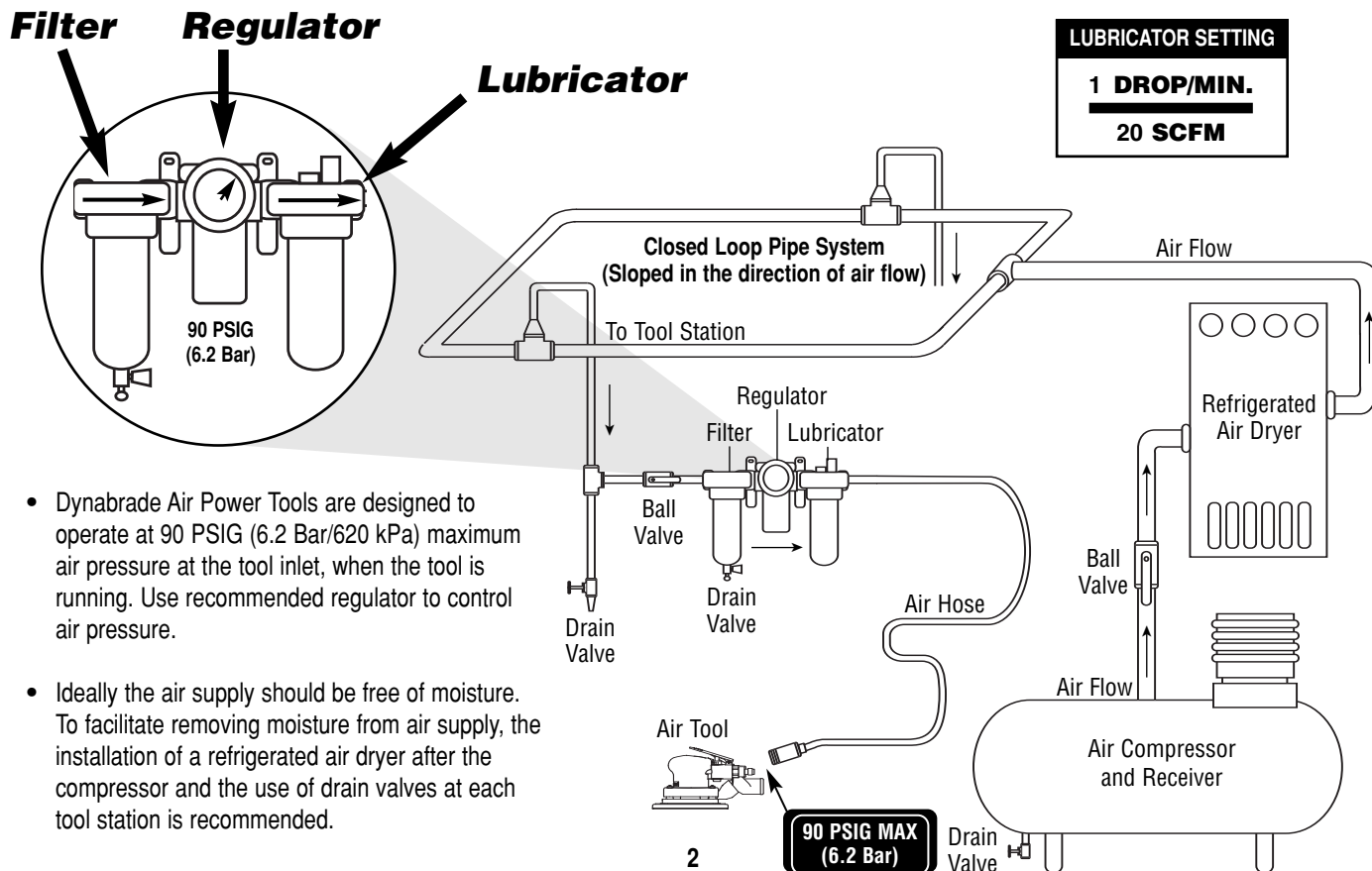

- Dynabrade Air Power Tools are designed to operate at 90 PSIG (6.2 Bar/620 kPa) maximum air pressure at the tool inlet, when the tool is running. Use recommended regulator to control air pressure.
- Ideally the air supply should be free of moisture. To facilitate removing moisture from air supply, the installation of a refrigerated air dryer after the compressor and the use of drain valves at each tool station is recommended.

# Maintenance Instructions

**Important:** To keep tool safe a preventative maintenance program is recommended whenever portable power tools are used.

- Use only genuine Dynabrade replacement parts to insure quality. To order replacement parts, specify **Model#**, **Serial#** and **RPM** of your air tool.
- It is strongly recommended that all Dynabrade rotary vane air tools be used with a Filter-Regulator-Lubricator to minimize the possibility of misuse due to unclean air, wet air or insufficient lubrication. Dynabrade recommends the following: **10681** Air Line Filter-Regulator-Lubricator — Provides accurate air pressure regulation, two-stage filtration of water contaminants and micro-mist lubrication of pneumatic components. Delivers up to 55 SCFM/1,558 LPM @ 145 PSIG/9.7 Bar (Max. Air Temperature of 140° F/60° C) **Note:** Two (2) 3/8" NPT Reducer Bushings are included.
- Dynabrade recommends one drop of air lube per minute for each 20 SCFM (example: if the tool specification states 40 SCFM, set the drip rate on the filter-lubricator to 2 drops per minute). Dynabrade Air Lube (P/N **95842**: 1 pt 473 ml) is recommended.

**Routine Preventative Maintenance:** Check free speed of Dynabug® II using a tachometer.

- Mineral spirits are recommended when cleaning the tool and parts. Do not clean tool or parts with any solvents or oils containing acids, esters, ketones, chlorinated hydrocarbons or nitro carbons.
- **DO NOT** clean or maintain tools with chemicals that have a low flash point (example: WD-40®).
- Air tool stampings must be kept legible at all times, if not, reorder and replace. User is responsible for maintaining specification information i.e.: Model #, S/N, and RPM.
- Blow air supply hose out prior to initial use.
- Visually inspect air hoses and fittings for frays, visible damage and signs of deterioration. Replace damaged or worn components.
- Refer to Dynabrade's Warning/Safety Operating Instructions Tag (Reorder No. **95903**) for safety information.

After maintenance is performed on tool, add a few drops of Dynabrade Air Lube (P/N **95842**) to the air line and start the tool a few times to lubricate air motor. Check for excessive tool vibration.

## Handling and Storage:

- Protect tool inlet from debris (See Notice Below).
- **DO NOT** carry tool by air hose.
- Protect abrasive accessories from exposure to water, solvents, high humidity, freezing temperature and extreme temperature changes.
- Store accessories in protective racks or compartments to prevent damage.

**Notice:** All Dynabrade motors use the highest quality parts and materials available and are machined to exacting tolerances. The failure of quality pneumatic motors can most often be traced to an unclean air supply or the lack of lubrication. Air pressure easily forces dirt or water contained in the air supply into motor bearings causing early failure. It often scores the cylinder walls and the rotor blades resulting in limited efficiency and power. Our warranty obligation is contingent upon proper use of our tools and cannot apply to equipment which has been subjected to misuse such as unclean air, wet air or a lack of lubrication during the use of this tool.

## Lifetime Warranty

All Dynabrade portable pneumatic power tools are rigorously inspected and performance tested in our factory before shipping to our customers. If a Dynabrade tool develops a performance problem and an inherent defect is found during normal use and service, Dynabrade will warrant this tool against defects in workmanship and materials for the lifetime of the tool. Upon examination and review at our factory, Dynabrade shall confirm that the tool qualifies for warranty status, and will repair or replace the tool at no charge to the customer. Normally wearable parts and products are NOT covered under this warranty. Uncovered items include bearings, contact wheels, rotor blades, regulators, valve stems, levers, shrouds, guards, O-rings, seals, gaskets and other wearable parts. Dynabrade's warranty policy is contingent upon proper use of our tools in accordance with factory recommendations, instructions and safety practices. It shall not apply to equipment that has been subjected to misuse, negligence, accident or tampering in any way so as to affect its normal performance. To activate lifetime warranty, customer must register each tool at [www.dynabrade.com](http://www.dynabrade.com). Dynabrade will not honor lifetime warranty on unregistered tools. A one-year warranty will be honored on all unregistered portable pneumatic power tools. Lifetime warranty applies only to portable pneumatic tools manufactured by Dynabrade, Inc. in the USA. Lifetime warranty applies only to the original tool owner; warranty is non-transferable.

## Machine Specifications

Model Number	Motor hp (W)	Motor RPM	Air Inlet Thread	Sound Level	Air Flow Rate SCFM (LPM)	Air Pressure PSIG (Bars)	Hose I.D. Inch (mm)	Weight Pound (kg)	Length Inch (mm)	Height Inch (mm)
10280	.15 (112)	10,000	1/4" NPT	81 dB(A)	14 (396)	90 (6.2)	1/4" (6)	1.6 (.7)	6-3/4 (172)	3.5 (91)
10281	.15 (112)	10,000	1/4" NPT	79 dB(A)	14 (396)	90 (6.2)	1/4" (6)	1.6 (.7)	8-1/8 (206)	3.7 (93)
10282	.15 (112)	10,000	1/4" NPT	83 dB(A)	14 (396)	90 (6.2)	1/4" (6)	1.6 (.7)	7 (180)	3.5 (91)
10283	.15 (112)	10,000	1/4" NPT	81 dB(A)	14 (396)	90 (6.2)	1/4" (6)	1.6 (.7)	7-1/4 (184)	3.5 (91)
10285	.15 (112)	10,000	1/4" NPT	83 dB(A)	14 (396)	90 (6.2)	1/4" (6)	1.6 (.7)	7-1/2 (190)	3.5 (91)
10287	.15 (112)	10,000	1/4" NPT	82 dB(A)	14 (396)	90 (6.2)	1/4" (6)	2.1 (.95)	8-1/8 (206)	3.75 (94)
10290	.15 (112)	10,000	1/4" NPT	83 dB(A)	14 (396)	90 (6.2)	1/4" (6)	1.6 (.7)	8-3/4 (222)	3.5 (91)
10291/10292	.15 (112)	10,000	1/4" NPT	81 dB(A)	14 (396)	90 (6.2)	1/4" (6)	1.8 (.7)	8-3/4 (222)	3.5 (91)

## Diagrams

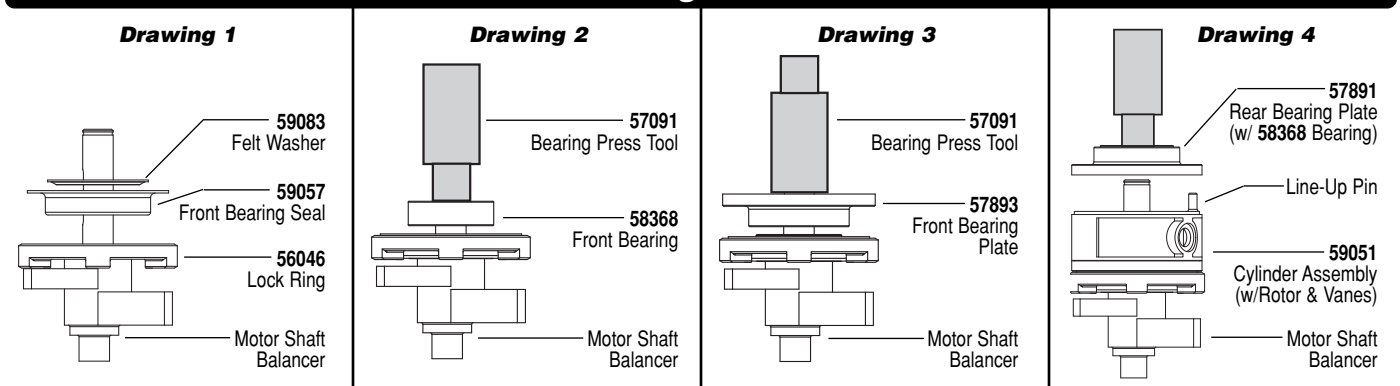

**Models:**

**10280, 10281, 10282,  
10283, 10285, 10287,  
10290, 10291, 10292**

# Dynabug® II Complete Assembly

HOUSING ASSEMBLY #	MODEL NUMBER
10220	10280
10221	10281
10222	10282
10223	10283
10225	10285
10227	10287
10230	10290
10231	10291
10232	10292

Index Key		
No.	Part #	Description
1	Screw (4)	
	96539	Models: 10280-85, 90-92
	96080	Model: 10287 Only
2	96538	Lock Washer (8)
3	Pads:	See Chart
4	95344	Screw
5	95935	Washer
6	54552	Bearing
7	57895	Pad Base (Standard)
	57875	Pad Base (w/Clips)
8	57896	Felt Seal
9	94590	Pin (2)
10	57899	Spring (2)
11	57834	Rubber Grip (2)
12	57898	Clip (2)
13	Shaft Balancer	
	57892	Models: 10280-85, 90-91
	57894	Model: 10287
14	56047	Key
15	56046	Lock Ring
16	59057	Front Bearing Seal
17	59083	Felt Washer
18	58368	Bearing (2)
19	57893	Front Bearing Plate
20	57113	Blade (5)/Rotor Set
21	59051	Cylinder (Incl. 01024 O-Ring)
22	01024	O-Ring
23	57891	Rear Bearing Plate
24	98463	Retaining Ring
25	57890	Isolator Post (4)
26	Housing:	See Chart
27	96539	Screw (4)
28	57888	Throttle Lever
29	94590	Pin
30	98459	O-Ring
31	58363	Valve Stem
32	59075	Speed Regulator
33	01025	O-Ring (2)
34	95697	Retaining Ring
35	01464	Seal
36	58365	Tip Valve
37	01468	Spring
38	01494	Inlet Bushing
39	57897	Vacuum Tube
40	96540	Vacuum Port Cover
41	57041	Comfort Platform

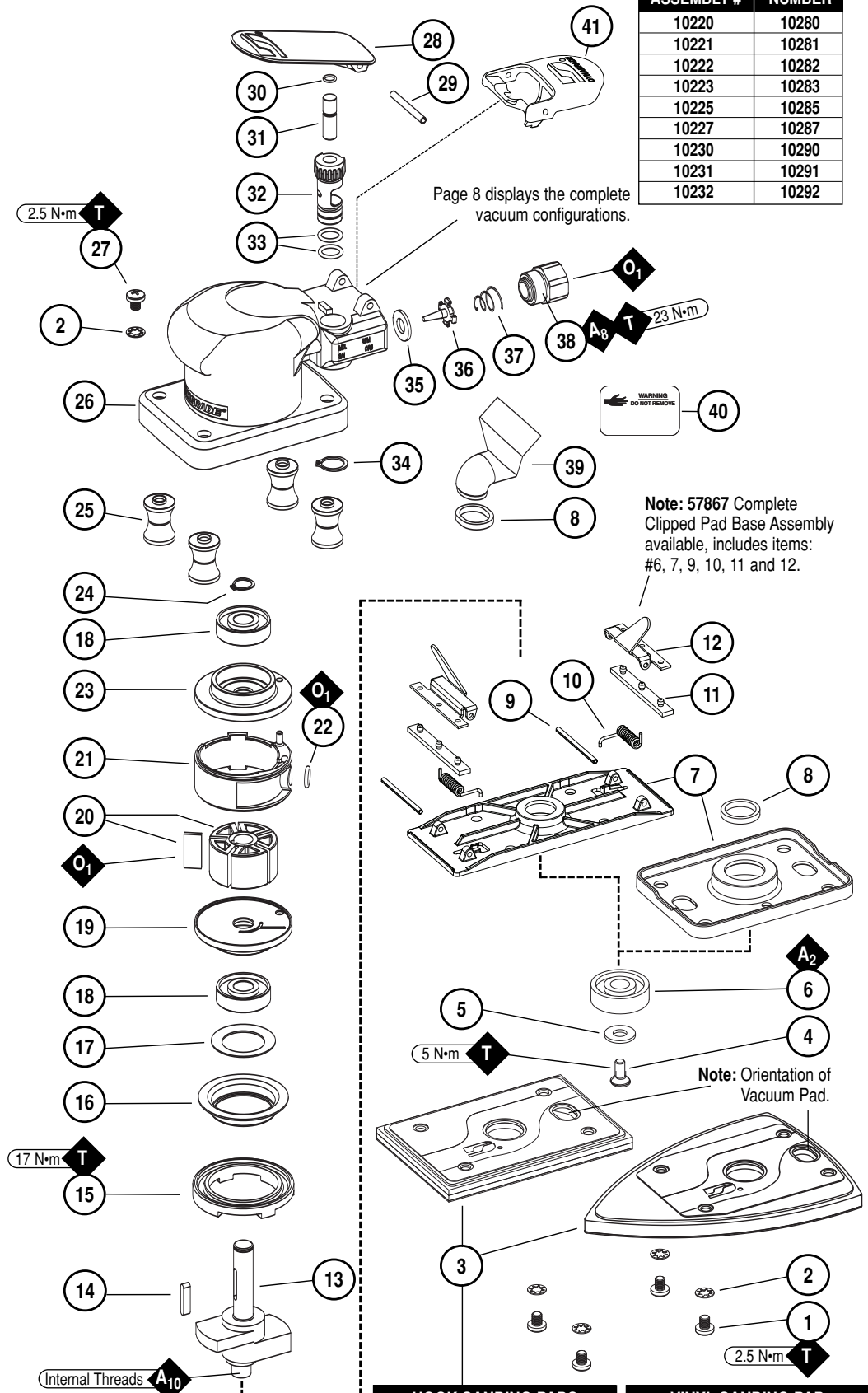

KEY	
<b>O</b>	Oil: O <sub>1</sub> = Air Lube
<b>A</b>	Adhesive: A <sub>2</sub> = Loctite #271 A <sub>8</sub> = Loctite #567 A <sub>10</sub> = Loctite #243
<b>T</b>	Torque: N·m x 8.85 = In. - lbs.

HOOK SANDING PADS	
Model No.	Pad No.
10280	56315
10281	56354
10282	56316
10283	56317
10285	56319
10290	56323
10292	56326

VINYL SANDING PAD	
Model No.	Pad No.
10287	56354
Note: For use with clipped pad base, 68mm x 175mm.	
LOOP SANDING PAD	
Model No.	Pad No.
10291	56324

## Disassembly/Assembly Instructions – Dynabug® II Sander

**Important: Manufacturers warranty is void if the tool is disassembled before the warranty expires.**

The Tool Repair Kit 57874 is available. This kit includes: 56058 Lock Ring Tool, 57092 Repair Collar, 57091 Bearing Press Tool, 95266 (3mm) Hex Key, 96034 (12mm) Hex Key and 96066 (3/4") Socket. These will assist in the disassembly and assembly of the Dynabug® II Orbital Sander. Please refer to the parts breakdown list for the proper part number identification.

### Disassembly:

1. Close off the air supply and disconnect the sander from the air supply line.
2. Place the 57092 Repair Collar around the housing and secure the sander in a vise so that the pad and/or pad base are facing up. **Note:** Do not over tighten the sander in the vise, as this will make the removal of the 56046 Lock Ring and the motor difficult.
3. Use a Phillips Screwdriver to remove the (4) 96539 Screws, (4) 96538 Washers and sanding pad.
4. Insert a 3/16" dia. drive punch through one of the holes in the pad base to prevent the shaft balancer from rotating. Use the 95266, (3mm) Hex Key to remove the 95344 Screw along with the 95935 Washer by turning it counterclockwise.
5. For vacuum models refer to the Vacuum Conversion Instructions on page 6 and diagrams on page 8, then remove the vacuum components.
6. Position two flat blade screwdrivers between the counterweight and the bearing area of the pad base. Pry the pad base away from the housing.
7. Use the small end of the 57091 Bearing Press Tool along with the 96232 (#2) Arbor Press to remove the 54552 Bearing from the pad base.
8. Use the 56058 Lock Ring Tool to loosen the 56046 Lock Ring by turning it counterclockwise.
9. Remove the 57896 Felt Seal from the shaft balancer and pull the motor out of the housing. Remove the 01024 O-Ring from the cylinder.
10. Use retaining ring pliers to remove the 98463 Retaining Ring.
11. Fasten the 96236 (2") Bearing Separator around the part of the 59051 Cylinder that is closest to the 57891 Rear Bearing Plate.
12. Place the bearing separator on the table of the arbor press so that the counterweight is pointing down and use a 1/4" dia. flat end drive punch to push the shaft balancer out of the 58368 Bearing. **Note:** If it's necessary, the 58368 Bearing can be removed from the bearing plate with the 96214 Bearing Removal Tool and the arbor press.
13. Remove the rotor, blades, and key.
14. Use the arbor press to push the shaft balancer, the 59083 Felt Washer, and the 58368 Bearing out of the 57893 Front Bearing Plate.
15. Remove the lock ring and the 59057 Seal.
16. Use the bearing separator and the arbor press to remove the 58368 Bearing and the felt washer from the shaft balancer.

**Motor Disassembly Complete.**

### Valve Disassembly:

1. Use a 2.5mm drive pin punch to remove the 94590 Pin, 57888 Throttle Lever and 57041 Comfort Platform.
2. Remove the 01494 Inlet Bushing by turning it counterclockwise.
3. Remove the spring, tip valve, and seal.
4. Use retaining ring pliers to remove the 95697 Retaining Ring and push the 59075 Speed Regulator out of the housing.
5. Remove the valve stem and the o-rings from the speed regulator.

**Valve Disassembly Complete.**

**Important: Clean and inspect all parts for wear or defect before assembling sander.**

### Assembly:

1. Install the 56046 Lock Ring onto the shaft balancer so that the side marked 'OFF' is toward the counterweight.
2. Install the 59083 Felt Washer into the 59057 Seal and place these onto the shaft balancer. (See Drawing 1)
3. Use the small end of the 57091 Bearing Press Tool along with the arbor press to install the 58368 Bearing onto the shaft balancer. (See Drawing 2)  
**Note:** Be certain that the felt washer does not get pinched between the bearing and the shaft balancer.
4. Use the large end of the 57091 Bearing Press Tool to install the 57893 Front Bearing Plate onto the 58368 Bearing. (See Drawing 3)  
**Note:** Pull the 59057 Seal up tight against the 57893 Front Bearing Plate.
5. Install the 56047 Key and the 57113 Rotor/blades (5) onto the shaft balancer. **Note:** These should be lubricated with the 95842 Dynabrade Air Lube (10W/NR or equivalent).
6. Install the 59051 Cylinder so that the short line-up pin fits to the front bearing plate.
7. Install the 58368 Bearing into the 57891 Rear Bearing Plate.
8. Align the cylinder line-up pin with the hole in the rear bearing plate. Use the small end of the 57091 Bearing Press Tool along with the arbor press to install the bearing/plate onto the shaft balancer as is shown in Drawing 4. Press the bearing/plate down until it touches the cylinder. This should create a snug fit between the bearing plates and the cylinder.
9. Install the 98463 Retaining Ring convex side up onto the shaft balancer and compress the ring into the groove on the shaft.
10. Install the 01024 O-Ring into the cylinder and apply a small amount of the Dynabrade Air Lube onto the o-ring.
11. **MARK** the edge of the housing motor opening to identify the location of the line-up notch on the inside of the housing.
12. Align the cylinder line-up pin with the '**NOTCH LOCATION MARK**' and install the motor into the housing. **Note:** Be certain that the line-up pin enters the notch in the housing.
13. Use the 57092 Repair Collar to carefully hold the tool in a vise so that the counterweight is pointing up.
14. Use the 56058 Lock Ring Tool to tighten the 56046 Lock Ring by turning it clockwise. Torque to 17 N-m/150 lbs. in. **Note:** Apply a slight amount of pressure down onto the lock ring while turning the lock ring tool counterclockwise. The lock ring should find the thread. Secure the lock ring by turning it clockwise.
15. Install the 57896 Felt Seal onto the shaft balancer.
16. For vacuum models refer to the Vacuum Conversion Instructions on page 6 and diagrams on page 8, install the vacuum components.
17. Apply a small amount of the Loctite® #271 (or equivalent) in two places on the inside of the pad base bearing pocket. Place the pad base on the tool plate of the arbor press so that the bearing pocket is facing up. Use the flat face of the arbor ram to push the 54552 Bearing into the pad base until the bearing is flush with the surface of the pad base.
18. Use the arbor press and the small end of the 57091 Bearing Press Tool to carefully install the pad base with the bearing onto the shaft balancer. Align the (4) 57890 Isolator Post with the 4 mounting holes in the pad base.
19. Insert a 3/16" dia. drive punch through one of the holes in the pad base to prevent the shaft balancer from rotating. Apply a small amount of the Loctite® #243 (or equivalent) to the internal threads of the shaft balancer and install the 95344 Screw along with the 95935 Washer. Torque to 5 N-m/45 lbs. in.
20. Use a Phillips Screwdriver to install the (4) 96539 Screws, (4) 96538 Washers and sanding pad. **Note:** When installing a vacuum pad orient the open oval pocket in the pad toward the back of the sander so that it will align with the vacuum tube.

**Motor Assembly Complete.**

## **Disassembly/Assembly Instructions – Dynabug® II Sander (cont.)**

### **Valve Assembly:**

1. Apply a small amount of the **95842** Dynabrade Air Lube (10W/NR or equivalent) to the **01025** O-Rings (2) and install these onto the **59075** Speed Regulator.
2. Install the speed regulator with o-rings into the housing and secure it with the **95697** Retaining Ring. Install the **98459** O-Ring onto the **58363** Valve Stem, apply a small amount of the Dynabrade Air Lube to the o-ring and install shorter end of the valve stem into the speed regulator.
3. Install the **01464** Seal, and the **58365** Tip Valve so that it fits under the end of the valve stem. Install the **01468** Spring so that the small end of the spring fits against the tip valve.
4. Apply a small amount of the Loctite® #567 (or equivalent) to the threads of the **01494** Inlet Bushing and install the bushing into the housing. Torque to 23 N-m/200 lbs. in.
5. First place **57041** Comfort Platform onto the housing (line-up over notches), next install **57888** Throttle Lever and secure it to the housing with the **94590** Pin.

**Valve Assembly Complete.**

## **Vacuum Conversion Instructions**

### **Disassemble:**

1. Close off the air supply and disconnect the sander from the air supply line.
2. Use the **96034** (12mm) Hex Key or the **96066** (3/4") Hex Socket to remove different muffler components.
3. Remove the sanding pad.

### **Assembly:**

1. Follow the Sander Assembly Instructions (Steps 15 - 20) to install the pad base and sanding pad when performing vacuum conversions. **Note:** Use Loctite® #380 (or equivalent) to secure the **57896** Felt Seal to the **57897** Vacuum Tube. The vacuum tube may have to be adjusted so that the felt seal sits flush and parallel to the pad base.

### **Non-Vac to Self-Generated Vac (Note: Remove 96540 Vacuum Port Cover Prior to Conversion)**

#### **For connection to Dynabrade Self-Contained Dust Collection Systems**

1. Apply 4 drops of the Loctite® #380 (or equivalent) to the **57897** Vacuum Tube and secure the vacuum tube to the **57083** Vacuum Adapter. Use Loctite® #380 (or equivalent) to attach the **57896** Felt Seal to the **57897** Vacuum Tube.
2. Install the **95526** O-ring onto the **57066** Muffler Body, positioning the o-ring between the shoulder and the 4 protrusions. Insert the **57066** Muffler Body with cone muffler and o-ring through the **57083** Vacuum Adapter.
3. Use the **96034** (12mm) Hex Key to secure all of these components to the housing.
4. Install the **57068** Vacuum Nozzle into the vacuum adapter so that the slots face out. Make sure that the raised portion of the nozzle aligns with the groove in the vacuum adapter.
5. Install the **57067** Vacuum Tube into the vacuum adapter so that the 2 holes in the vacuum tube align with the 2 holes in the vacuum adapter.
6. Insert the **96197** Pin through the vacuum adapter and the **57067** Vacuum Tube.
7. Attach the sander to the dust collection receptacle.

### **Non-Vac to Central Vac (Note: Remove 96540 Vacuum Port Cover Prior to Conversion)**

1. Apply 4 drops of the Loctite® #380 (or equivalent) to the **57897** Vacuum Tube and secure the vacuum tube to the **57093** Vacuum Adapter. Use Loctite® #380 (or equivalent) to attach the **57896** Felt Seal to the **57897** Vacuum Tube.
2. Insert the **69274** Muffler Assembly through the **57093** Vacuum Adapter.
3. Use the **96066** (3/4") Hex Socket to secure all of these components to the housing.
4. Attach the sander to the central vacuum system.

### **Self-Generated Vac to Central Vac**

1. Use a 1/8" dia. drive punch to remove the **96197** Pin.
2. Remove the **57067** Vacuum Tube by turning the tube clockwise and pulling it out of the vacuum adapter.
3. Pull the **57068** Vacuum Nozzle out of the vacuum adapter.
4. Use the **96034** (12mm) Hex Key to remove the **57066** Muffler Body, **57065** Cone Muffler, **95526** O-Ring and **57083** Vacuum Adapter.
5. Apply 4 drops of the Loctite® #380 (or equivalent) to the **57897** Vacuum Tube and install it onto the **57093** Vacuum Adapter. Use Loctite® #380 (or equivalent) to attach the **57896** Felt Seal to the **57897** Vacuum Tube.
6. Install the **57896** Felt Seal onto the **57897** Vacuum Tube. Insert the muffler body and cone muffler through the **57093** Vacuum Adapter.
7. Use the **96066** (3/4") Hex Socket to secure **69274** Muffler Assembly and vacuum components to the housing.
8. Attach the sander to the central vacuum system.

### **Central Vac to Self-Generated Vac**

1. Use the **96066** (3/4") Hex Socket to remove **69274** Muffler Assembly and vacuum components.
2. Install the **95526** O-Ring onto the **57066** Muffler Body, positioning the o-ring between the shoulder and 4 protrusions.
3. Remove the **57897** Vacuum Tube from the **57093** Vacuum Adapter.
4. Apply 4 drops of the Loctite® #380 (or equivalent) to the **57897** Vacuum Tube and install it onto the **57083** Vacuum Adapter. Use Loctite® #380 (or equivalent) to attach the **57896** Felt Seal to the **57897** Vacuum Tube.
5. Insert the **57066** Muffler Body with cone muffler and o-ring through the **57083** Vacuum Adapter and use the **96034** (12mm) Hex Key to secure all of these components to the housing.
6. Install the **57068** Vacuum Nozzle into the vacuum adapter so that the slots face out. Make sure that the raised portion of the nozzle aligns with the groove in the vacuum adapter.
7. Install the **57067** Vacuum Tube into the vacuum adapter so that the 2 holes in the vacuum tube align with the 2 holes in the vacuum adapter.
8. Insert the **96197** Pin through the vacuum adapter and the **57067** Vacuum Tube.
9. Attach the sander to the dust collection receptacle.

**Tool Assembly Complete. Please allow 30 minutes for adhesives to cure before operating tool.**

**Important:** Motor should now be tested for proper operation at 90 PSIG. If motor does not operate properly or operates at a higher RPM than marked on the tool, the tool should be serviced to correct the cause before use. Before operating, place 2-3 drops of Dynabrade Air Lube (P/N **95842**) directly into air inlet with throttle lever depressed. Operate tool for 30 seconds to determine if tool is operating properly and to allow lubricating oils to properly permeate motor.

Loctite® is a registered trademark of Loctite Corp.

# Preventative Maintenance Schedule

For All Dynabug® II Sanders

This service chart is published as a guide to expectant life of component parts. The replacement levels are based on average tool usage over one year. Dynabrade Inc. considers one year usage to be 1,000 hours.

## Parts Common to all Models:

Index #	Part Number	Description	Number Required	High Wear 100%	Medium Wear 70%	Low Wear 30%	Non-Wear 10%
1	See Note	Screw	4		T		
2	96538	Lock Washer	8		T		
3	See Note	Pads	1			X	
4	95344	Screw	1		T		
5	95935	Washer	1		T		
6	54552	Bearing	1	T			
7	See Note	Pad Base	1				X
8	57896	Felt Seal	2	T			
9	94590	Pin	2				X
10	57899	Spring	2				X
11	57834	Rubber Grip	2			X	
12	57898	Clip	2				X
13	See Note	Shaft Balancer	1				X
14	56047	Key	1	T			
15	56046	Lock Ring	1				X
16	59057	Front Bearing Seal	1		T		
17	59083	Felt Seal	1	T			
18	58368	Bearing	2	T			
19	57893	Front Bearing Plate	1			X	
20	57113	Blade (5)/Rotor Set	1	T			
21	59051	Cylinder	1			X	
22	01024	O-Ring	1		T, L		
23	57891	Rear Bearing Plate	1			X	
24	98463	Retaining Ring	1		T, D		
25	57890	Isolator Post	4			X	
26	See Note	Housing	1				X
27	96539	Screw	4		T		
28	57888	Throttle Lever	1				X
29	94590	Pin	1		T		
30	98459	O-Ring	1		T		
31	58363	Valve Stem	1		T		
32	59075	Speed Regulator	1			X	
33	01025	O-Ring	2		T		
34	95697	Retaining Ring	1		T		
35	01464	Seal	1		T		
36	58365	Tip Valve	1		T		
37	01468	Spring	1		T		
38	01494	Inlet Bushing	1				X
39	57093	Vacuum Adapter	1			X	
40	57041	Comfort Platform	1				X
41	57065	Cone Muffler	1		T		
42	56027	Muffler Insert	2	T			
43	69359	Muffler Body	1	T			
44	57897	Vacuum Tube	1				X
45	96540	Vacuum Port Cover	1		T		

LEGEND	
T	Included in Tune-Up Kit
X	Type of wear, no other comments apply.
L	Easily lost. Care during assembly/disassembly.
D	Easily damaged during assembly/disassembly.
R	Replace each time tool is disassembled.



98222 – Tune-Up Kit

**Note:** Please refer to page 4 of tool manual for specific part number and description.

## Comfort Platform Removal Instructions

1. Use a 1/8" drift pin and a hammer to remove 94590 Pin.
2. Remove throttle lever and 57041 Comfort Platform.
3. Place throttle lever back into position between holes in housing.
4. Secure throttle lever in place using 98927 Pin (Sold Separately) by hammering pin back into housing. **Removal and Installation Complete.**

# Machine Exhaust Assemblies

## Vacuum-Ready

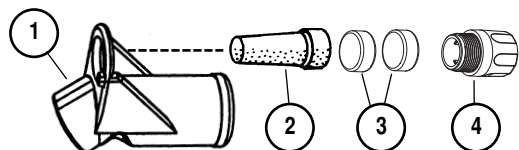

## Non-Vacuum

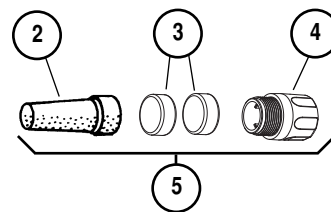

### Index Key

No.	Part #	Description
1	57093	Vacuum Adapter
2	57065	Cone Muffler
3	56027	Muffler Insert (2)
4	69359	Muffler Cap
5	69274	Muffler Assembly

Optional: 30 quantity Muffler Insert available, P/N 56054.

## Optional Accessories

FIND THE MOST CURRENT OFFERING OF SUPPORT DOCUMENTS AND ACCESSORIES @ [WWW.DYNABRADE.COM](http://WWW.DYNABRADE.COM)



### 98222 Motor Tune-Up Kit

- Includes assorted parts to help maintain and repair motor.

### 59469 Drop-In Motor

**Note: Not for use with model 10287**

- Allows quick and easy replacement. No motor adjustments needed.



### 96232 (#2) Arbor Press

- This arbor press is ideal for the disassembly and assembly of air motors.



### 96346 2" Bearing Separator

- Use the separator to remove gears and bearings.

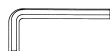

### 95266 – 3mm Hex Wrench



### 96343 Retaining Ring Pliers

- Internal/external retaining ring pliers. Tip diameter - 0.038" (0.96mm)



### Dynabrade Air Lube

- Formulated for pneumatic equipment.
- Absorbs up to 10% of its weight in water.
- Prevents rust and formation of sludge.
- Keeps pneumatic tools operating longer with greater power and less down time.

95842: 1 pt. (473 ml)

95843: 1 gal. (3.8 L)



### 57874 Repair Kit:

- Contains special tools for disassembly/assembly of machine.

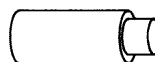

### 57091 Bearing Press Tool

- This tool is used to push against the I.D. of the bearing.



### 96066 SOCKET (3/4")

- This tool is a thin wall socket specifically designed for installing and removing 69359 Muffler Bodies.

## Reference Contact Information

- American National Standards Institute – ANSI**  
25 West 43<sup>rd</sup> Street  
Forth Floor  
New York, NY 10036  
Tel: 1 (212) 642-4900  
Fax: 1 (212) 398-0023
- Government Printing Office – GPO**  
Superintendent of Documents  
Attn. New Orders  
P.O. Box 371954  
Pittsburgh, PA 15250-7954  
Tel: 1 (202) 512-1803
- Power Tool Institute, Inc.**  
P.O. Box 818  
Yachata, Oregon 97498-0818  
Tel: 1 (503) 547-3185  
Fax: 1 (503) 547-3539
- European Committee for Standardization**  
Rue de Stassart 36  
B - 1050 Brussels, Belgium

Visit Our Web Site: [www.dynabrade.com](http://www.dynabrade.com)

Email: [Customer.Service@Dynabrade.com](mailto:Customer.Service@Dynabrade.com)

